

8000 SERIES

STEAM & HOT OIL



Operating Parameters

MEDIA

Steam, Hot Oil

PRESSURE*

175 PSI (Steam), 100 PSI (Hot Oil)

TEMPERATURE*

450° F (Steam), 600° F (Hot Oil)

SPEED*

600 RPM

THREADS

- 1/2" to 4" NPT
- BSP or ISO228 Available
- Quick Release

MATERIAL

- Cast Iron Housing with Stainless Steel Sleeve
- Steel Shaft with Hardened Nickel Plating

CONFIGURATION OPTIONS

Mono Flow & Dual Flow Configurations Available

* See Performance Charts For Details

Features & Benefits

Ideal For Steam Applications

Designed for operation in a variety of steam applications.

Safety

An anti-torque lug prevents rotation of the housing while in operation.

No Lubrication Needed

The special carbon graphite bearing is lubricated by the process fluid and requires no additional lubrication.

Hot Oil Applications

8000HO offers the same design features as the standard 8000 Series but with a special high temperature seal ring for hot oil applications.

Stainless Steel Insert

The stainless steel housing insert in the 8000T Series makes this joint a favorite in the textile industry

8000 SERIES ROTARY UNIONS • MONO FLOW														
PART NUMBERS	Nominal Pipe Size (A)	Inlet (B)	Left Hand Thread				Right Hand Thread				Quick Release			
			Standard Spring	Description	Heavy Duty Spring	Description	Standard Spring	Description	Heavy Duty Spring	Description	Standard Spring	Description	Heavy Duty Spring	Description
	1/2	1/2	430483C	L8200P	730215C	L8200P-HD	430484C	R8200P	730216C	R8200P-HD	430533C	Q8200P	730214C	Q8200P-HD
	3/4	3/4	430485C	L8300P	730223C	L8300P-HD	430486C	R8300P	730224C	R8300P-HD	730534C	Q8300P	730225C	Q8300P-HD
	1	1	730856C	L8400-T	-	-	730857C	R8400-T	-	-	430535C	Q8400P	730232C	Q8400P-HD
	1-1/4	1-1/4	430489C	L8500P	730244C	L8500P-HD	430490C	R8500P	730245C	R8500P-HD	430536C	Q8500P	730246C	Q8500P-HD
	1-1/2	1-1/2	730496C	L8600P	730506C	L8600P-HD	730497C	R8600P	730507C	R8600P-HD	730498C	Q8600P	730508C	Q8600P-HD
	2	2	460617C	L8700P	730269C	L8700P-HD	460618C	R8700P	730270C	R8700P-HD	460616C	Q8700P	730271C	Q8700P-HD
	2-1/2	2	430495C	L8800P	730278C	L8800P-HD	430496C	R8800P	730279C	R8800P-HD	430539C	Q8800P	730280C	Q8800P-HD
	3	2-1/2	430497C	L8900P	730290C	L8900P-HD	430498C	R8900P	730291C	R8900P-HD	430540C	Q8900P	730292C	Q8900P-HD
	4	4	430501C	L81100P	730322C	L81100P-HD	430502C	R81100P	730323C	R81100P-HD	430542C	Q81100P	730324C	Q81100P-HD

8000 SERIES ROTARY UNIONS • DUAL FLOW														
PART NUMBERS	Nominal Pipe Size (A)	Inlet (B)	Right Hand Thread				Left Hand Thread				Quick Release			
			Standard Spring	Description	Heavy Duty Spring	Description	Standard Spring	Description	Heavy Duty Spring	Description	Standard Spring	Description	Heavy Duty Spring	Description
	1/2	1/2	430504C	R8200S	730219C	R8200S-HD	430503C	L8200S	730218C	L8200S-HD	430543C	Q8200S	730217C	Q8200S-HD
	3/4	3/4	430506C	R8300S	730227C	R8300S-HD	430505C	L8300S	730226C	L8300S-HD	430544C	Q8300S	730228C	Q8300S-HD
	1	1	730859C	R8400S-T	-	-	730858C	L8400S-T	-	-	430545C	Q8400S	730238C	Q8400S-HD
			730861C	XR8400S-T	-	-	730860C	XL8400S-T	-	-	430546C	XQ8400S	730235C	XQ8400S-HD
	1-1/4	1-1/4	430512C	R8500S	730248C	R8500S-HD	430511C	L8500S	730247C	L8500S-HD	430547C	Q8500S	730249C	Q8500S-HD
	1-1/2	1-1/2	730500C	R8600S	730523C	R8600S-HD	730499C	L8600S	730522C	L8600S-HD	730501C	Q8600S	730524C	Q8600S-HD
	2	2	460648C	R8700S	730273C	R8700S-HD	460647C	L8700S	730272C	L8700S-HD	460595C	Q8700S	730274C	Q8700S-HD
			430520C	R8800S	730285C	R8800S-HD	430517C	L8800S	730284C	L8800S-HD	430550C	Q8800S	730286C	Q8800S-HD
	2-1/2	2	430521C	R8800S	730282C	R8800S-HD	430518C	L8800S	730281C	L8800S-HD	430551C	Q8800S	730283C	Q8800S-HD
			430522C	R8800S	730288C	R8800S-HD	430519C	L8800S	730287C	L8800S-HD	430552C	Q8800S	730289C	Q8800S-HD
	3	2-1/2	430526C	R8900S	730296C	R8900S-HD	430523C	L8900S	730293C	L8900S-HD	430553C	Q8900S	730299C	Q8900S-HD
			430527C	R8900S	730297C	R8900S-HD	430524C	L8900S	730294C	L8900S-HD	430554C	Q8900S	730300C	Q8900S-HD
			430528C	R8900S	730298C	R8900S-HD	430525C	L8900S	730295C	L8900S-HD	430555C	Q8900S	730301C	Q8900S-HD
	4	4	431532C	R81100S	730326C	R81100S-HD	430531C	L81100S	730325C	L81100S-HD	430557C	Q81100S	730327C	Q81100S-HD

8000HO SERIES ROTARY UNIONS • MONO FLOW • HOT OIL							
PART NUMBERS	Nominal Pipe Size (A)	Right Hand Thread		Left Hand Thread		Quick Release	
		Part Number	Description	Part Number	Description	Part Number	Description
	1/2	740226C	R8200P-HO	740225C	L8200P-HO	740227C	Q8200P-HO
	3/4	740211C	R8300P-HO	740210C	L8300P-HO	740212C	Q8300P-HO
	1	740242C	R8400P-HO	740241C	L8400P-HO	740243C	Q8400P-HO
	1-1/4	740349C	R8500P-HO	740348C	L8500P-HO	740350C	Q8500P-HO
	1-1/2	740279C	R8600P-HO	740278C	L8600P-HO	740280C	Q8600P-HO
	2	740275C	R8700P-HO	740274C	L8700P-HO	740276C	Q8700P-HO
	2-1/2	740425C	R8800P-HO	750026C	L8800P-HO	780995C	Q8800P-HO
	3	740190C	R8900P-HO	740189C	L8900P-HO	740459C	Q8900P-HO

8000HO SERIES ROTARY UNIONS • DUAL FLOW • HOT OIL							
PART NUMBERS	Nominal Pipe Size (A)	Right Hand Thread		Left Hand Thread		Quick Release	
		Part Number	Description	Part Number	Description	Part Number	Description
	1/2	740222C	R8200S-HO	740221C	L8200S-HO	-	Q8200S-HO
	3/4	740324C	R8300S-HO	740323C	L8300S-HO	740325C	Q8300S-HO
	1	740321C	R8400S-HO	740320C	L8400S-HO	740322C	Q8400S-HO
	1-1/4	740388C	R8500S-HO	740387C	L8500S-HO	740389C	Q8500S-HO
	1-1/2	740282C	R8600S-HO	740281C	L8600S-HO	740283C	Q8600S-HO
	2	740272C	R8700S-HO	740271C	L8700S-HO	740273C	Q8700S-HO
		740314C	R8800S-HO	740313C	L8800S-HO	740315C	Q8800S-HO
	2-1/2	740267C	R8800S-HO	740266C	L8800S-HO	740268C	Q8800S-HO
		740286C	R8900S-HO	740285C	L8900S-HO	740287C	Q8900S-HO

Mono Flow

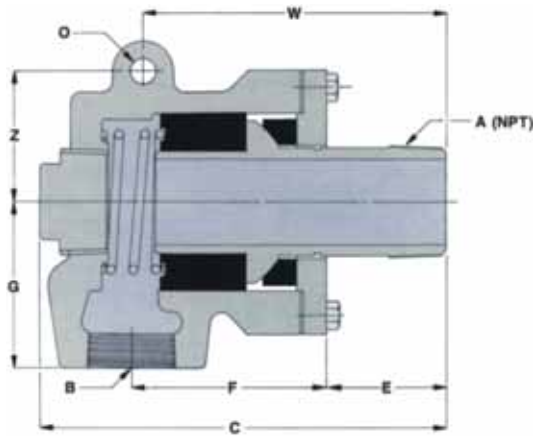

Dual Flow

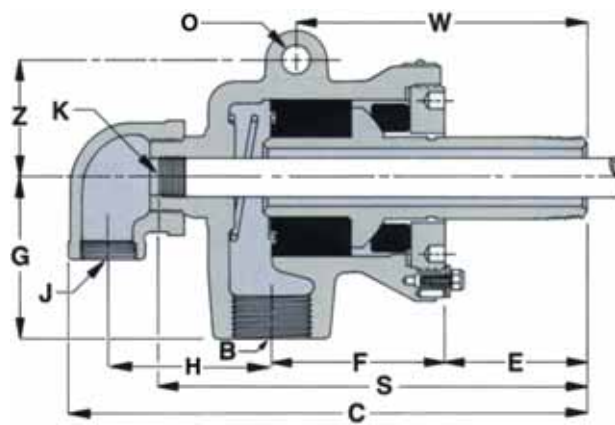

8000 SERIES ROTARY UNIONS • STEAM & HOT OIL • MONO FLOW (in.)									
DIMENSIONS	Nominal Pipe Size (A)	Inlet B (NPT)	F	E	G	Overall Length (C)	W	Z	O
	1/2	1/2	2-1/2	2-1/8	2	6-1/4	4-7/16	1-5/8	15/32
		Quick Release							
	3/4	3/4	2-1/2	2-3/16	2-3/8	6-3/8	4-11/16	1-13/16	15/32
		Quick Release							
	1	1	2-3/4	2-5/16	2-5/8	7-1/8	4-7/8	1-7/8	15/32
		Quick Release							
	1-1/4	1-1/4	3-3/16	2-1/2	3	8-1/8	5-5/8	2-1/8	5/8
		Quick Release							
	1-1/2	1-1/2	3-3/4	2-1/2	3-1/2	8-13/16	6	2-7/8	5/8
Quick Release									
2	2	4	2-9/16	4	9-1/2	6-9/16	3-1/8	5/8	
	Quick Release								
2-1/2	2	5-3/16	3-3/16	4-7/16	10-7/8	8	3-9/16	11/16	
	Quick Release								
3	2-1/2	5-3/4	3-5/8	4-9/16	12-3/16	8-1/2	3-31/32	7/8	
	Quick Release								
4	4	8-1/8	5-7/16	6-5/16	16-7/8	13-1/2	5-1/8	1-3/32	
	Quick Release								

8000 SERIES ROTARY UNIONS • STEAM & HOT OIL • DUAL FLOW (in.)													
DIMENSIONS	Nominal Pipe Size (A)	Inlet B (NPT)	Outlet J (NPT)	Siphon Tap K (NPSM)	C	F	E	G	S	W	Z	O	H
	1/2	1/2	1/2	1/8	7-1/2	2-1/2	2-1/8	2	6-1/16	4-7/16	1-5/8	15/32	2-1/4
	3/4	3/4	1/2	1/4	7-11/16	2-1/2	2-3/16	2-3/8	6-1/4	4-11/16	1-13/16	15/32	2-5/16
	1	1	1/2	3/8	8-3/4	2-3/4	2-5/16	2-5/8	6-15/16	4-7/8	1-7/8	15/32	2-5/8
			1/2	1/4									
	1-1/4	1-1/4	1/2	1/2	9-1/4	3-3/16	2-1/2	3	7-7/8	5-5/8	2-1/8	5/8	3-1/8
	1-1/2	1-1/2	3/4	3/4	10-3/8	3-3/4	2-1/2	3-1/2	8-5/8	6	2-7/8	5/8	3-9/16
	2	2	1	3/4	11-11/16	4	2-9/16	4	9-1/2	6-9/16	3-1/8	5/8	4
	2-1/2	2	1-1/4	3/4	14-1/8	5-3/16	3-3/16	4-7/16	11-1/4	8	3-9/16	11/16	5-1/16
				1									
1-1/4													
3	2-1/2	1-1/4	1	17	5-3/4	3-5/8	4-9/16	12-1/2	8-1/2	3-31/32	7/8	5-9/16	
		1-1/4	1-1/4										
		1-1/2	1-1/2										
4	4	2-1/2	2	24-1/4	8-1/8	5-7/16	6-5/16	18-1/8	13-1/2	5-1/8	1-3/32	7-3/4	



8000 SERIES ROTARY UNIONS • 1/2" to 1 1/4" REPAIR PARTS • STEAM ONLY										
REPAIR PARTS	Nominal Pipe Size	Mono Flow Housing	Dual Flow Housing	Rotating Siphon Housing Part Number	LH Shaft (NPT)	RH Shaft (NPT)	Quick Release Shaft	Graphite Bearing	8000 Series Spring	8000 Series Hot Oil Heavy Duty Spring
	1/2	487240C	487242C	Contact factory	471050C	471051C	471818C	484247C	484246C	487912C
	3/4	487248C	487252C	Contact factory	481759C	481760C	471894C	484005C	484039C	487909C
	1	487153C	487148C	441147C	441878C	441879C	471094C	484007C	484026C	487872C
	1-1/4	487214C	487217C	Contact factory	481753C	481754C	471095C	484009C	484033C	487911C
								Rotating Siphon Models Only		
Nominal Pipe Size	Graphite Seal Ring	Housing Gasket	Housing Seal Nut	Lock Washer	Socket Head Cap Screw	Outlet Elbow	Siphon Packing Nut	Siphon Packing Ring Set		
1/2	484245C	484361C	487239C	484037C	854295C	487234C	482039C*	482745C*		
3/4	484004C	484038C	487304C	484037C	854295C	487235C	482038C	481473C		
1	484006C	484025C	487159C	484023C	854295C	487160C	482040C	481475C		
1-1/4	484008C	484032C	487213C	484031C	854295C	487212C	482041C	471476C		

8000 SERIES ROTARY UNIONS • 1 1/2" to 4" REPAIR PARTS • STEAM ONLY										
REPAIR PARTS	Nominal Pipe Size	Mono Flow Housing	Dual Flow Housing	Rotating Siphon Housing Part Number	LH Shaft (NPT)	RH Shaft (NPT)	Quick Release Shaft	Graphite Bearing	8000 Series Spring	8000 Series Hot Oil Heavy Duty Spring
	1-1/2	Contact Factory	Contact Factory	N/A	481756C	481757C	471096C	484011C	484034C	487910C
	2	Contact Factory	Contact Factory		471055C	471056C	471097C	484301C	484300C	487903C
	2-1/2	Contact Factory	Contact Factory		471777C	471776C	471775C	485416C	485415C	463306C
	3	Contact Factory	Contact Factory		471796C	471795C	471797C	485467C	485466C	487305C
	4	Contact Factory	Contact Factory		471838C	471837C	471836C	485594C	485595C	463025C
Nominal Pipe Size	Graphite Seal Ring	Housing Gasket	Housing Flange	Housing Cap Screw	Housing Plug for Mono Flow Models	Outlet Elbow for Dual Flow Models Only	Siphon Packing Nut for RSP Models	Siphon Packing Ring for RSP Models		
1-1/2	484010C	463514C	463513C	855366C	N/A	487171C	482042C	481477C		
2	484249C	487927C	487926C	855236C	N/A	487155C	482042C	481477C		
2-1/2	485420C	485421C	487208C	485545C	Contact Factory	487209C	N/A	N/A		
3	485470C	485471C	487236C	485545C	Contact Factory	487303C	N/A	N/A		
4	485596C	485593C	487238C	485605C	Contact Factory	487329C	N/A	N/A		

Performance Charts

8000 Series (with saturated steam)

1/2"

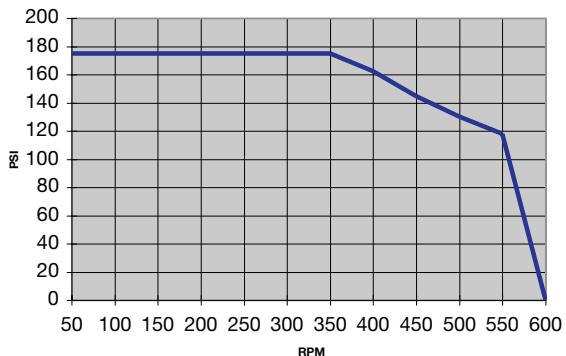

3/4" & 1"

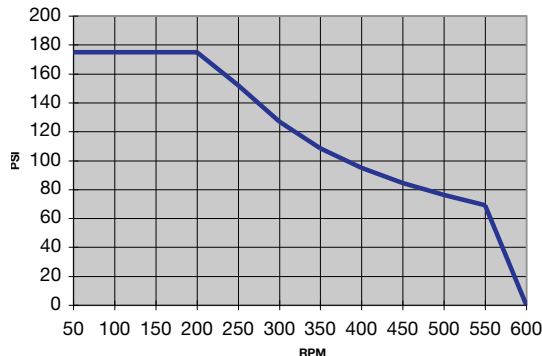

1 1/4"

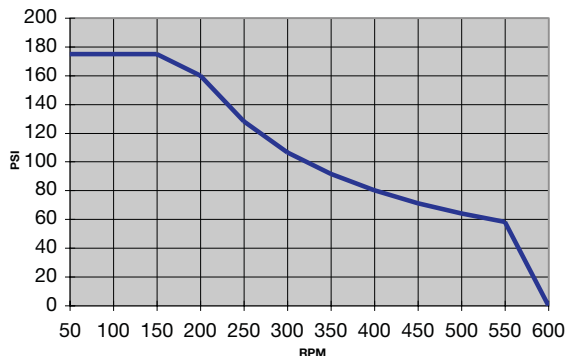

1 1/2"

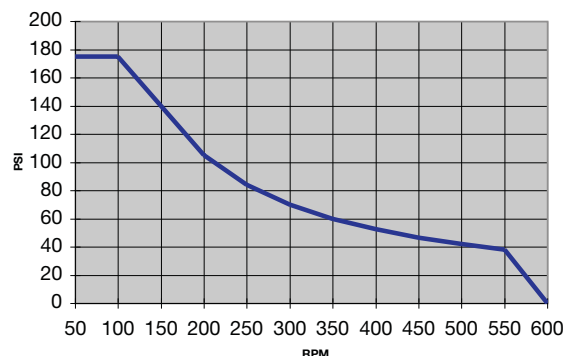

2"

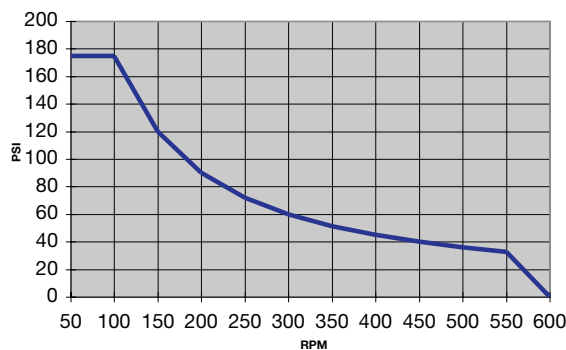

2 1/2"

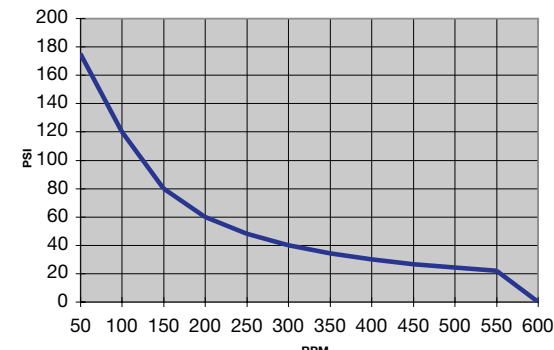

3"

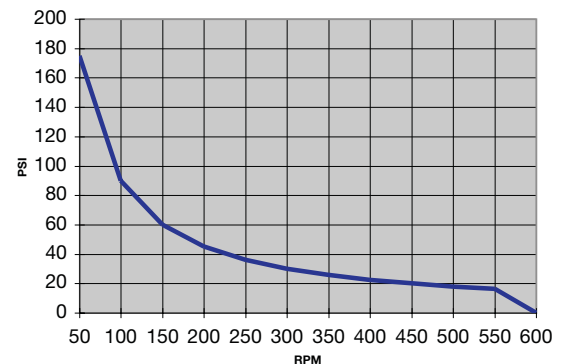

4"

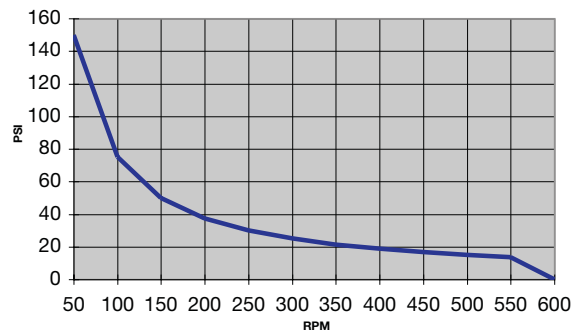

Performance Charts

8000HO Series (Hot Oil)

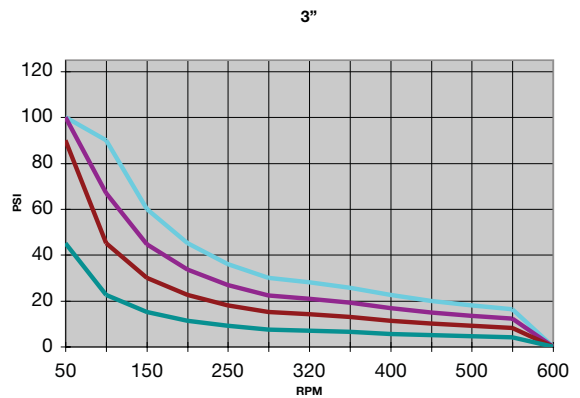
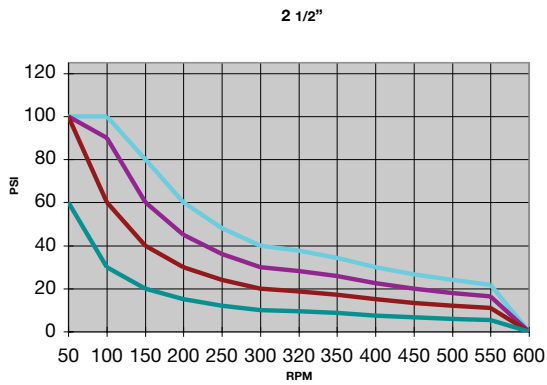
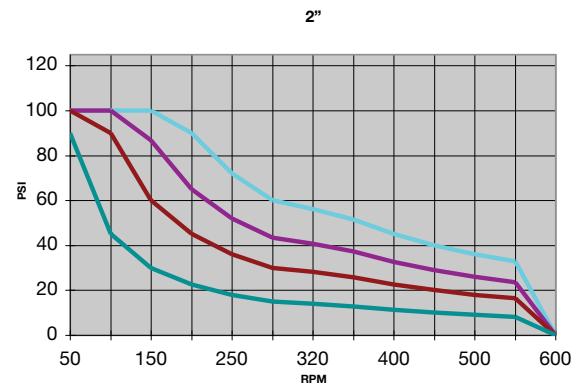
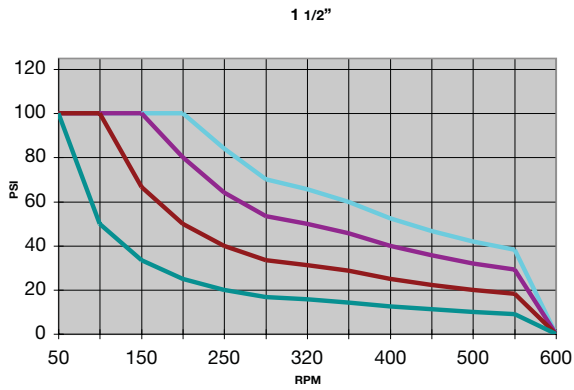
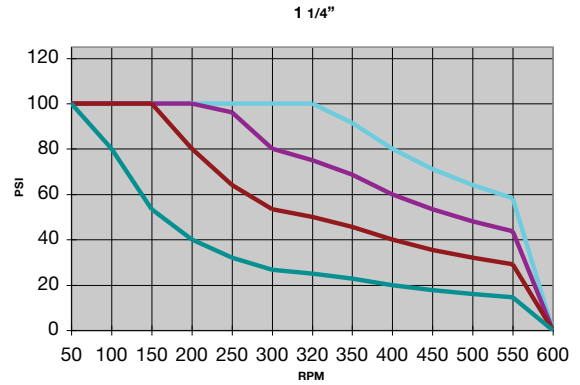
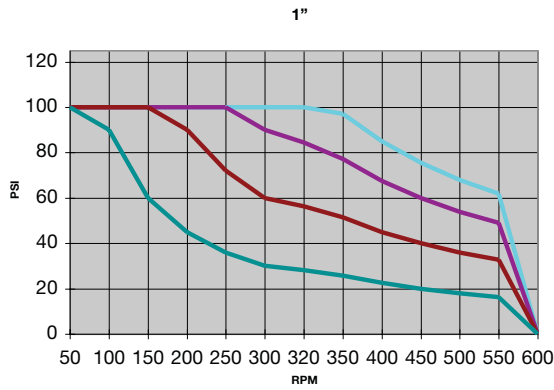
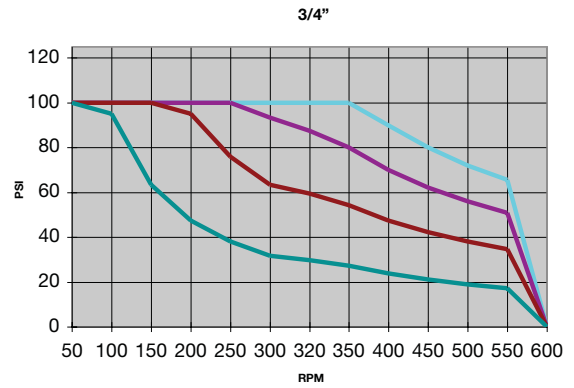
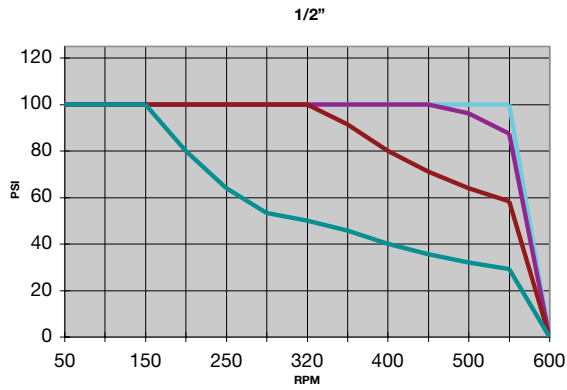

600° 550° 500° 450°